



Free Flow Exhaust Installation Instructions

PART NUMBER D660-0006

APPLICATION: 2006-07 550i (up to 3/07 production)

Thank you for purchasing a Dinan High Performance Muffler! Some mechanical skill is required to install this muffler. If you are not familiar with this procedure, we strongly recommend that you arrange for a qualified BMW repair facility to perform this installation.

INSTALLATION:

1. Hold the new Dinan muffler up under the stock muffler. Line up the exhaust tip on the new muffler with the exhaust tip on the stock muffler. The new Dinan Muffler Pipe is a slip fit over the stock pipe. You will need to have enough overlap to seal well (2.0" – 2.5"). The stock pipe will need to be cut at a point 2.0" to 2.5" longer than where the new Dinan muffler pipes end. Mark the Pipes at this point and check the mark position with the measurements in the next step.

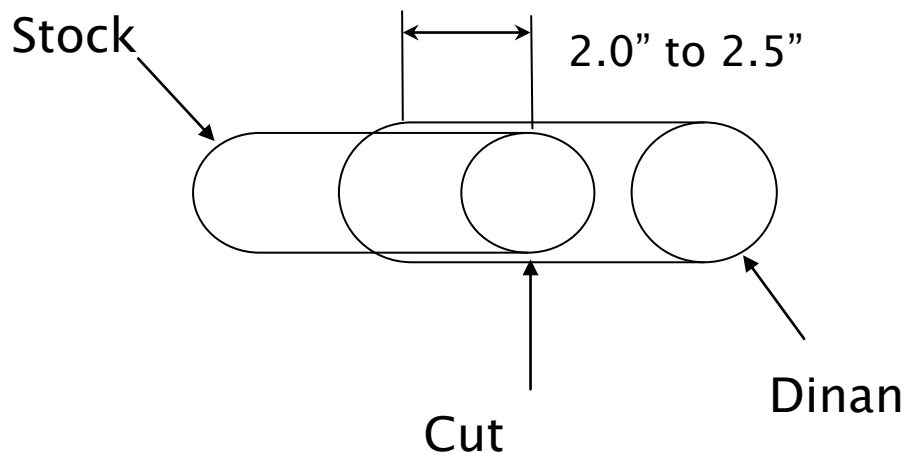

2. Check to see if your marks are just after the oval part of the pipe and before the hanger at the front of the differential. See figure 2.

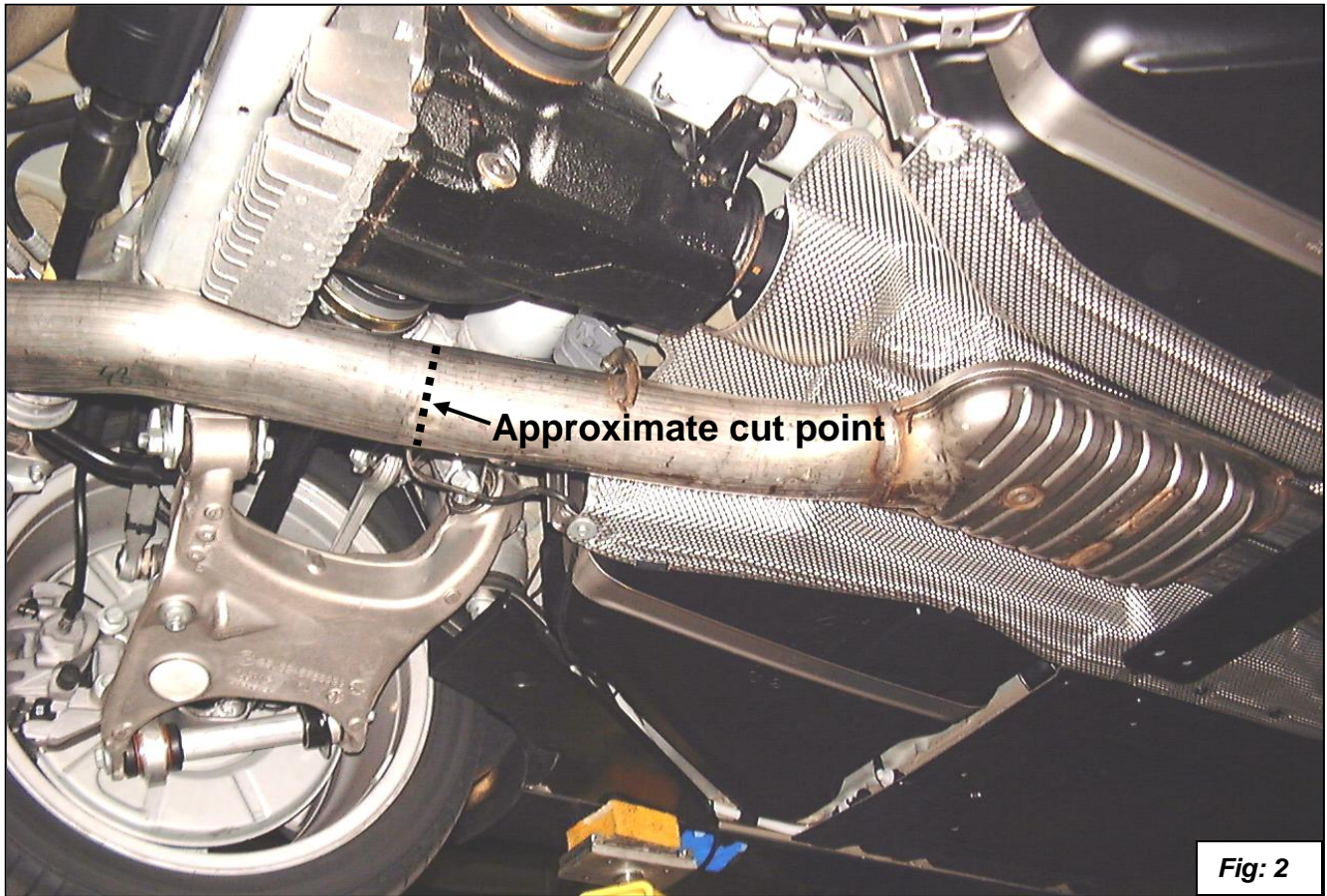

Cut: When you are confident you will have enough overlap, cut the pipe. (Be careful not to cut into any surrounding parts.)

3. Disconnect the vacuum hose from the actuator (1) on the muffler. See figure 4. Remove the stock muffler by unbolting the rubber hanger mounts from the car. Each of the two hangers are held in place with 13mm nuts, the front hanger has two and the rear has one. See figures 3 and 4.

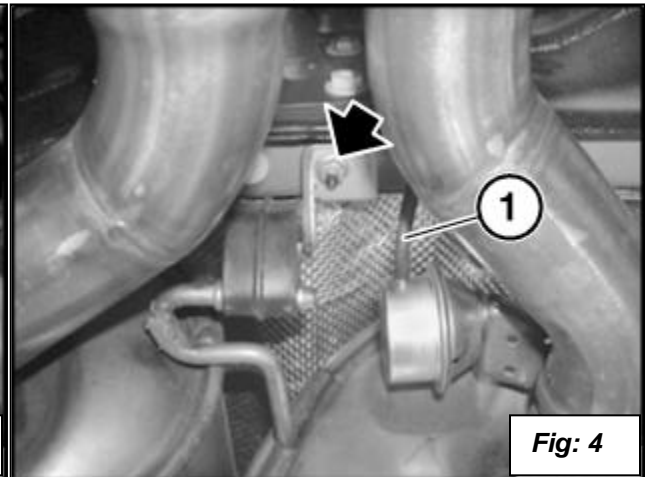
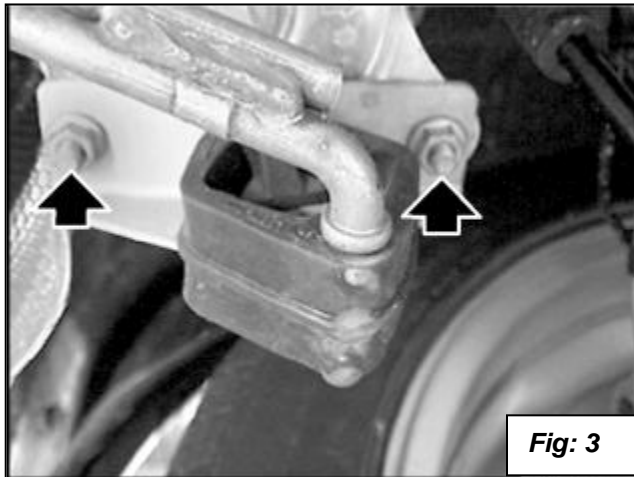

4. Deburr the inside of the stock exhaust on the car and clean the outside surface to ensure a good seal.
5. Remove the rubber hangers with mount from the stock mufflers by pulling them off the wire hangers on the muffler.
6. Install the metal spacer tubes into the rubber hangers as shown in figure 5 by pushing them into the hanger until they are flush.

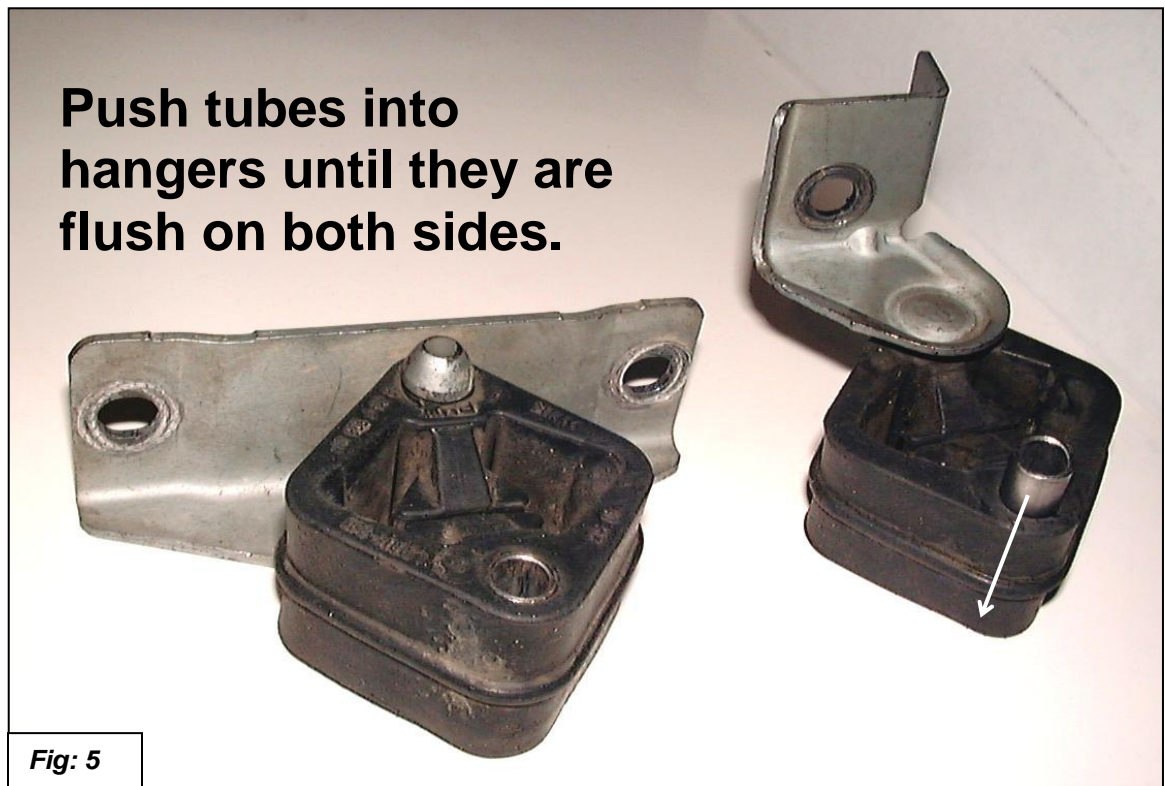

7. Install the rubber hangers with spacers and mounts onto the car as shown. The front hanger goes on in the stock location. The rear hanger goes onto the inner stud as shown in figure 6.

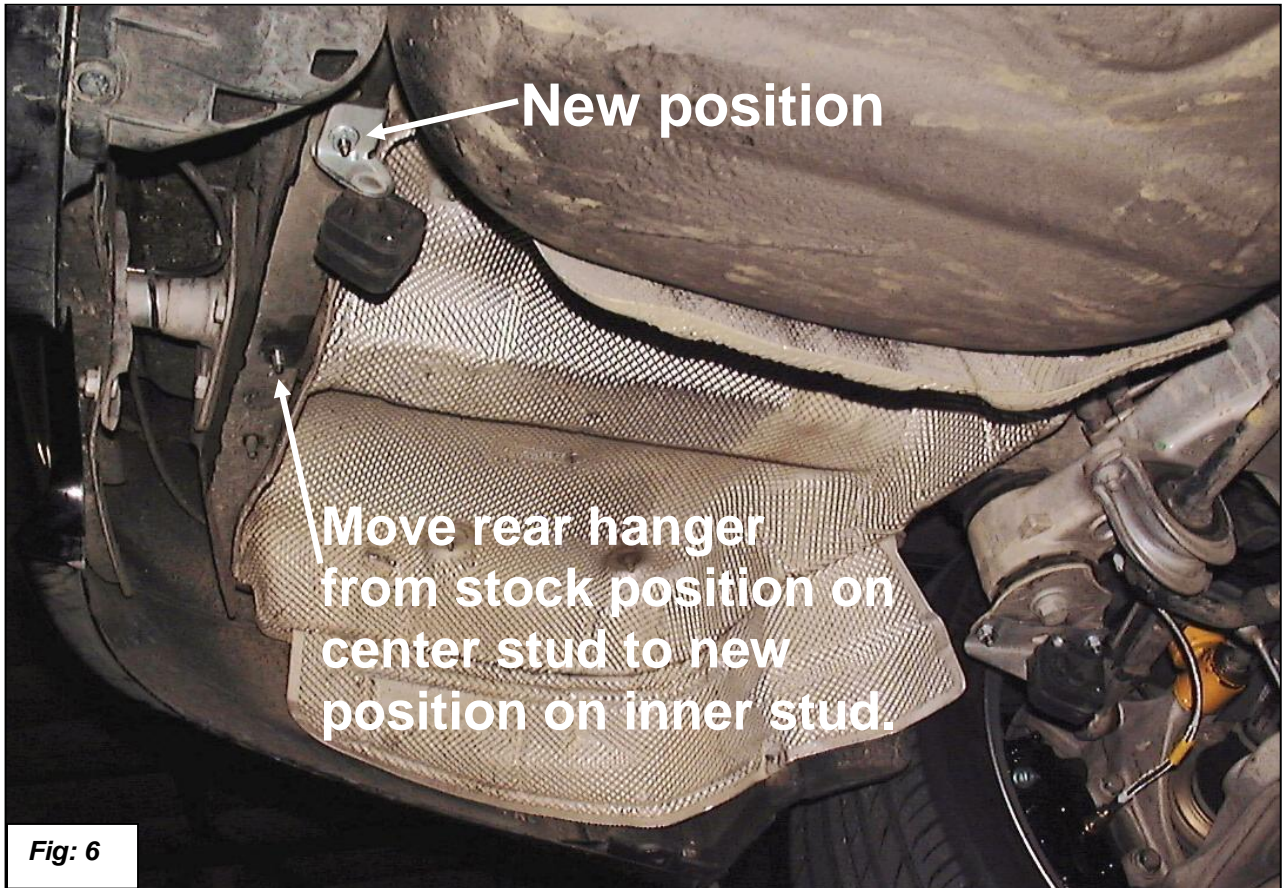

8. Slide the Dinan muffler over the stock tube as you place it in position. It may be necessary to rotate the muffler into position after sliding it over the pipe. See figure 7.



9. Install the muffler by attaching to the hangers you installed in step 7. Use the supplied bolts, washers and copper lock nuts. Adjust the muffler for best fit centering the exhaust tip in the bumper cut out. The rubber hangers should be angled forward as shown in figures 8 and 9. When the exhaust gets hot it grows in length and the hangers will hang straight.

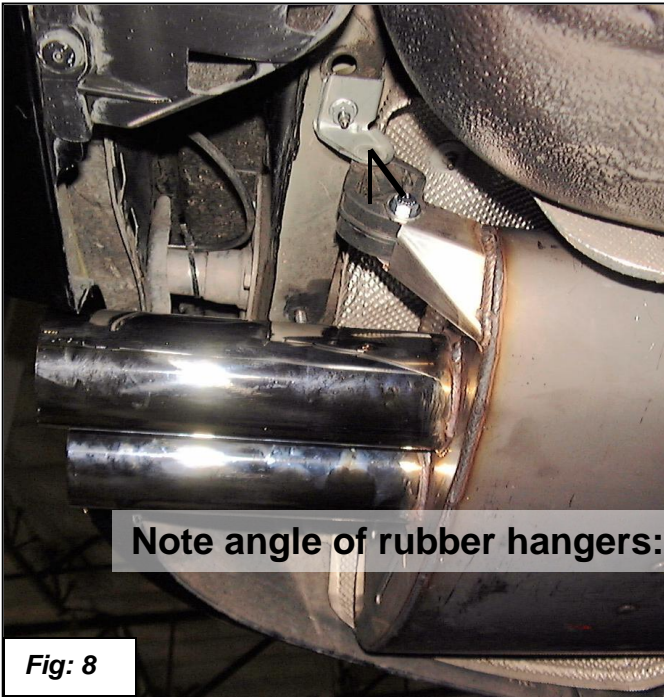

Note angle of rubber hangers:

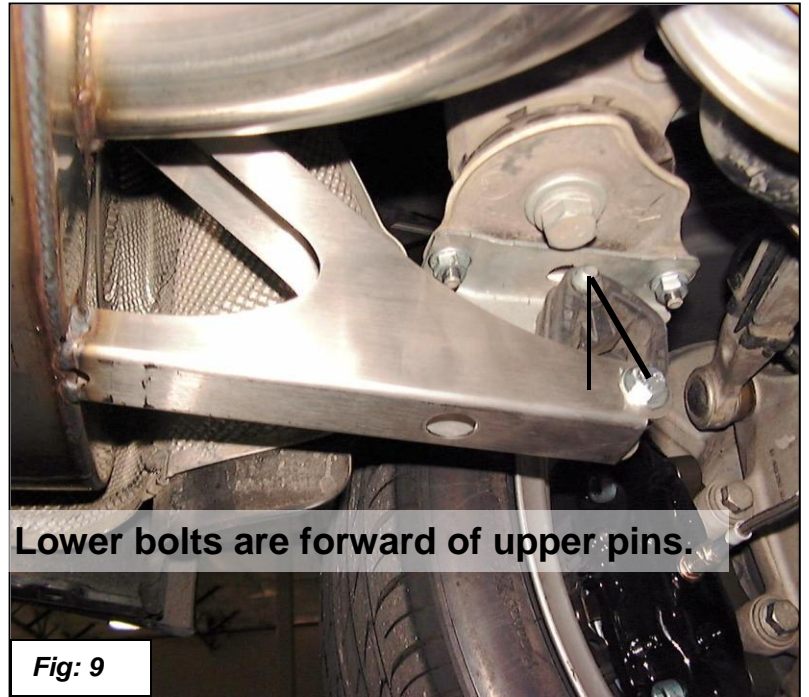

Lower bolts are forward of upper pins.

10. Visually inspect the muffler. Check for at least $\frac{1}{2}$ " clearance in all areas. Make sure the polished tips are centered in the bumper cutouts. See figures 10.
11. Rotate clamps so that you have at least $\frac{1}{2}$ " clearance around the bolt. Remember that the exhaust grows in length as it gets hot. Tighten the clamps to 45 ft.-lbs, as you make sure the tips stay centered. Adjust as needed.
12. Plug the vacuum line with the supplied plug and wire tie to the bumper mount.



Happy Motoring!